



Big Dutchman®



Residue Treatment

From the poultry house to the pelletising unit:
All you need from one single source!

We have thought residue treatment through!

In addition to egg and meat production, the sensible utilisation of poultry excrement is becoming more and more important to modern poultry producers. With OptiSec and OptiPlate, Big Dutchman has effective methods for manure drying on offer. Manure dried by these two systems can be stored safely in special manure storehouses. The correct distribution

and transport systems must always be a part of the residue treatment concept as well. Dry manure can be used in many ways, for example as valuable fertiliser. Pelletising the manure helps further its commercial possibilities. Big Dutchman can offer well thought-out, innovative solutions for this purpose as well.

All components for residue treatment from one source and thus ideally combined: this is our claim of creating an added value beyond egg production for our customers.

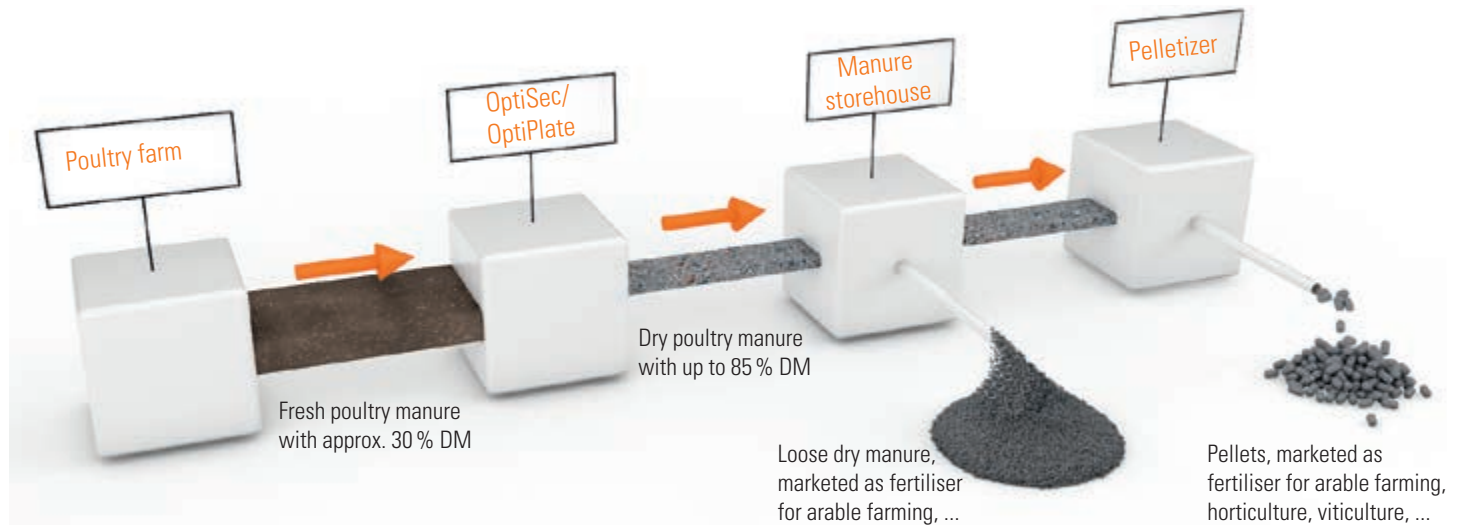

OptiSec manure drying tunnel

Optimal drying of manure, high capacity, cost-efficient solution

OptiSec is a manure drying tunnel from Big Dutchman that was developed for optimal and efficient drying of fresh or pre-dried manure from layer houses (up to a dry matter content of

85 percent). OptiSec is available for 20,000 to 300,000 layers, has 4 to 18 tiers and is characterised by its large intake capacity, which is achieved thanks to a variable length

of up to 60 m, a large belt width of 1.78 m and a substrate layer that is approx. 10 cm thick.

Important features

- ✓ high intake capacity due to wide belts;
- ✓ for 20,000 to 300,000 bird places;
- ✓ filling station is integrated into the top tier so no additional tier is required;
- ✓ very even distribution of the fresh manure on the belts leads to very uniform drying;
- ✓ manure belt drive has a special pressure unit for a good power transmission to the belt;
- ✓ a patented roller bearer ensures circulation of the air and smooth running of the belts.



OptiSec manure drying tunnel with 16 tiers

How it works

With the start of the manure removal process, the fresh manure (dry matter content of approx. 30 percent) is transported from the barn to the OptiSec filling station. The amount of manure put on the manure belt is determined by weight and measured by electronic load cells. The load cells coordinate the speeds of both the manure belts inside the barn and the belts of the drying tunnel. Two counter-rotating augers spread a uniform layer of manure onto the topmost drying belt and all subsequent belts until the filling process is finished. An emergency stop on every tier ensures that no major damage occurs in case of malfunctioning.



OptiSec and manure storage in the same building

Filling station – feeds the dryer with fresh manure

The filling station is integrated into the top tier of the manure drying tunnel. This economic solution has the advantage of requiring only little additional space.

The amount of manure arriving, the speed of the belts and the speed of the two distributing augers are well coordinated, thus ensuring an even distribution of the fresh manure on the drying belts. This is an important prerequisite for a uniform drying of the manure on the tunnel's perforated belts.



The distributing augers fill the belts evenly

Chopper – breaks up possible manure chunks

The chopper can be mounted at the end of any tier. We recommend installing it after approximately two thirds of the total drying distance. The chopper consists of a quickly rotating shaft to which chain links are attached. These chain links break up any manure chunks before they are fully dried, which makes for considerably more uniform manure drying. Two easy-to-open doors facilitate cleaning and maintenance. The drive unit is installed on the outside, which protects it from dirt and makes maintenance very easy.



Chopper installed as standard feature with 10 cm long chain links



Chopper installed between tiers 3 and 4

Manure belt drive, auger idler, patented roller bearer

The manure belt drive features a special pressure unit which makes for good power transmission. Pulling the 1.78 m wide belts loaded with fresh manure forward is therefore no problem. The manure belts are perforated and thus ensure an optimal drying of the manure.

An auger with two conveying directions is used as idler for the manure belts. This auger also transports dust as well as manure residues to the left and right onto the next tier for a smooth running of the system.

Beneath the bottom tier, an additional manure belt without perforations collects small particles and dust from the upper tiers. This solid belt is cleaned when the dry manure is removed so that the floor beneath the tunnel remains clean.

The patented roller bearers consist of a galvanized tube onto which plastic rolls are fitted. The rolls are formed in such a way that the manure belt rests on the roller in certain places only. The manure belt perforations are therefore not covered by the bearers, which ensures sufficient circulation of air and makes pulling forward of the belt easy.



Standard manure belt drive and auger idler in each tier

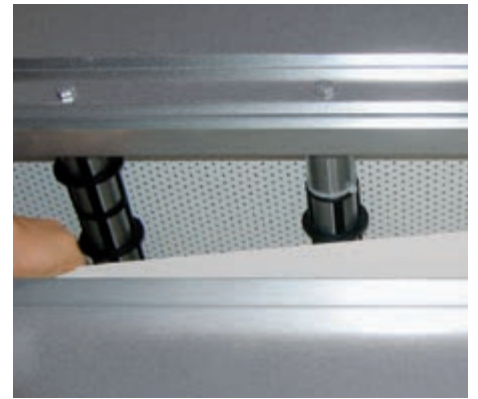

Patented roller bearer (EP 2003412)



View of the top tier



View of a tier filled with manure

OptiPlate steel plate drying system

Optimal drying of manure, compact design, installation at gable possible

OptiPlate is a highly-efficient steel plate drying system with a compact design. It dries fresh poultry manure from aviaries and cage systems to a dry matter content of up to 85 percent.

OptiPlate is available for 20,000 to 240,000 layers and with one to six tiers. Each tier consists of two perforated steel plate levels (2000 mm wide x 317 mm long, hole diameter

5 mm, optionally available in stainless steel). The layer of substrate on these levels may be up to 20 cm thick.



View of the topmost tier with a manure rake at the end to loosen the manure layer

A manure rake in the upper tier loosens the manure layer and thus also improves the drying effect.

As an option, the drive unit can be equipped with a chopper, which can be placed variably between the tiers.

Similar to OptiSec, this chopper consists of a quickly rotating shaft with chain links. These chain links break up any manure chunks before they are fully dried, which makes for considerably more uniform manure drying.

Filling station with weighing system – supplies fresh manure evenly

The filling station, located above the top tier of the dryer, has a slewing belt that distributes the fresh manure evenly over the entire width of the dryer plates.

The integrated weighing system allows a uniform height of the manure layer (up to 20 cm). The speed of the plates is adjusted to correspond to the volume flow of the manure for this purpose. This is one of the main prerequisites for a uniform drying process.



Filling station: two OptiPlate dryers, installed front-to-front, are supplied by one conveyor belt

Drive and idler – prevent plates from deviating

Each tier has its own drive, including mechanical and electric devices for monitoring. This increases security and keeps the risk of damage in case of malfunctions to a minimum. An idler unit in each tier, installed at the other end of the dryer, is also equipped with systems for process monitoring. These systems recognise plates that are positioned incorrectly, for example. The topmost idler has a scraper to prevent clogging of the perforated plates. Another scraper below the dryer removes small particles and dust, thus keeping the floor below the dryer clean.



Open OptiPlate with scraper floor



Closed OptiPlate

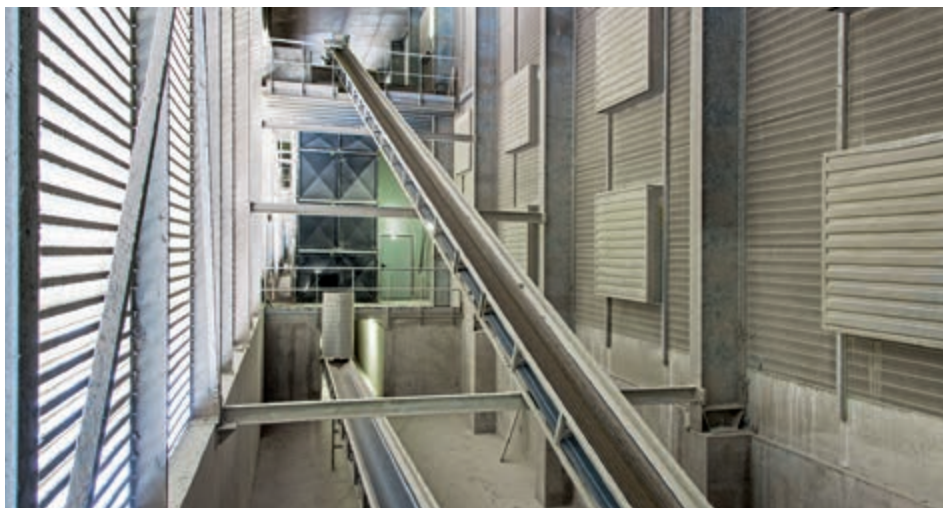

OptiPlate with transport belts to be filled with fresh manure and to remove the dry manure

Important features

- ✓ large drying capacity per square meter of surface;
- ✓ compact, modular design with a high intake capacity;
- ✓ perforated steel plates allow for a layer height of the fresh manure of up to 20 cm;
- ✓ very stable, rugged technology;
- ✓ can also be installed at the gable side in case of tunnel ventilation;
- ✓ easy to maintain.

Ventilation concepts for OptiSec and OptiPlate

Using the heat of the barn's exhaust air

Using the remaining heat of the barn's exhaust air for the drying process makes sense and is very efficient. Fans push the warm exhaust air into the pressure corridor at up to 4 m³/h and bird. A positive pressure of 30 Pa is used with OptiSec, and up to 150 Pa for OptiPlate. In the pressure corridor, the warm air passes through

all tiers of OptiSec or OptiPlate from one side to the other along the entire system length. The perforated manure belts or steel plates ensure that the air passes not only over the manure but through it, which makes for considerably better manure drying. The result is a dry matter content of up to 85 percent!

The compact plate dryer OptiPlate can be installed along the long side of the house as well as at the gable. The latter requires a tunnel ventilation concept.



View inside the pressure corridor of OptiSec

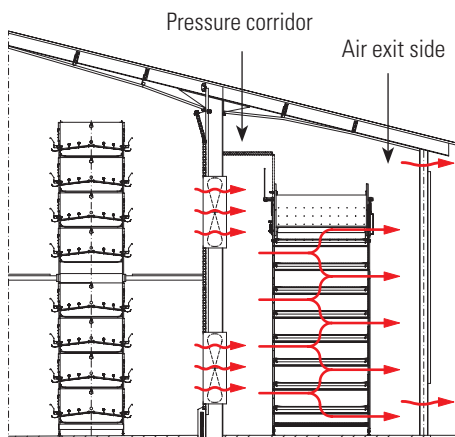

The dryer is located at the barn's long side



Air exit side



Cost-efficient solution: one OptiSec for three layer houses with 90,000 layers each; the air reaches the dryer underground

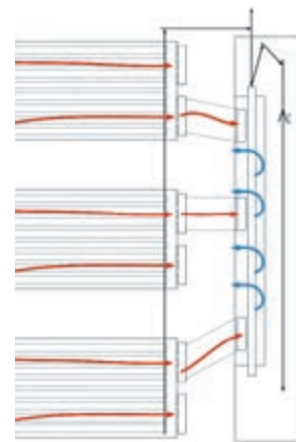

Environmentally friendly solution: two OptiPlate dryers for 205,000 layers at the barn's long side; the dried manure is transported into the manure storehouse underground

Unique control for OptiSec and OptiPlate

Fully-automatic operation, group control, permanent monitoring of the system

The control for the manure dryers, specifically developed by Big Dutchman, has some very clever functions and guarantees a high operational and functional reliability. It can operate as stand-alone solution or as a module of the amacs controller. A separate base unit is installed in an individual control cabinet for this purpose. The operating data can be displayed and checked directly at the touch

screen. If a network has been established, all data can also be transferred to an external PC in real time (optional). A convenient remote enquiry is thus always possible. All recorded data can be saved on a long-term basis when connected with amacs.

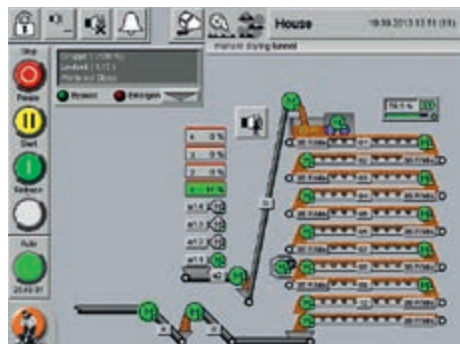

OptiSec: operation at the touch screen



OptiPlate: operation at the touch screen



Control cabinet with amacs module »OptiSec manure drying tunnel«

Parameters that can be controlled fully automatically

- ✓ up to twenty manure removal groups;
- ✓ up to twenty manure cross belts;
- ✓ manure cross belts can be assigned individually to manure removal groups;
- ✓ variable belt speeds of the dryer depending on the amount of manure, no start/stop during filling;
- ✓ individual speed monitoring by means of a sensor in each tier;
- ✓ the percentage of total manure belt length to be pulled forward for filling can be defined very accurately;
- ✓ fully-automatic operation of the dryer with up to twelve starting times per day.

Group control – using OptiSec and OptiPlate flexibly and to full capacity

To align the manure flow from the barn ideally with the capacity of the dryer, manure should be removed automatically, based on a fixed time schedule and in previously defined manure removal groups (up to twenty are possible). Based on the barn layout, each manure removal group is assigned longitudinal and cross manure belts, which may even come from different barns. For example, one group might be filled from an external dosing hopper. This especially makes sense if manure from rearing and layer houses can be dried together. The different types of manure can be mixed in this hopper to create a uniform mass that is then filled into the dryer.

Additionally, up to twelve starting times can be programmed per day. The dryer then starts fully automatically at these times. Each starting time can be assigned to multiple manure

removal groups that start either simultaneously or one after another.

The percentage of the total longitudinal manure belt length to be cleaned can also be defined. This helps achieving ideal drying

results without any additional effort. Starting times can also be programmed for the night. The dryer must be inspected visually every day, of course.

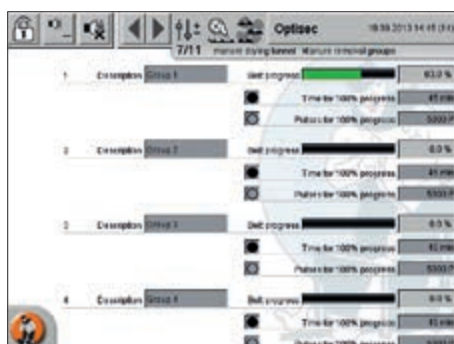

View of the belt progress per manure removal group

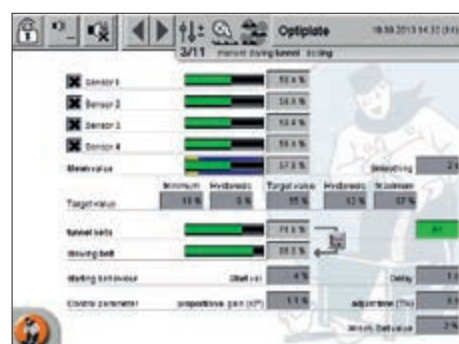

View of the dosing

Manure storehouses and distribution systems

Secure and stable storage of the dry manure and ideal distribution

Manure storehouses are an essential requirement for secure and environmentally sound storage of excrement, whether fresh or dry manure.

The necessary storage capacity, and thus the

size and form of each manure storehouse, is calculated individually, based on the number of birds as well as the breed, the maximum storage time and the available space.

For ideal filling of the storehouse, Big

Dutchman can offer different systems for manure distribution. Let our experts advise you which solution best fits your requirements.

Manure storehouse with distribution system: plough scraper

The plough-shaped distribution system, installed on the conveyor belt, is the ideal solution for narrow and long storehouses. The plough scraper moves permanently back and

forth along the longitudinal conveyor belt and thus fills the storehouse in an optimal manner along its entire length. Dry manure is only supplied to the distributor belt from one end of

the storehouse. The manure can also be dried further in the storehouse when only thin layers are added.

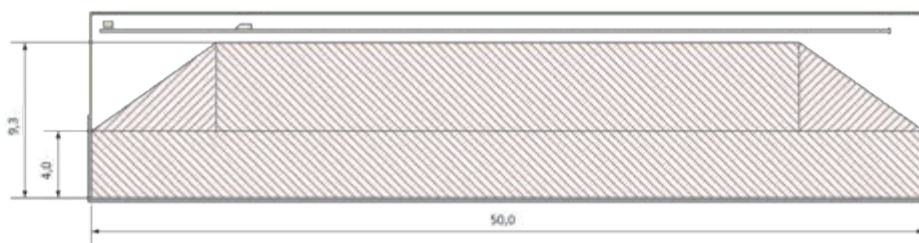
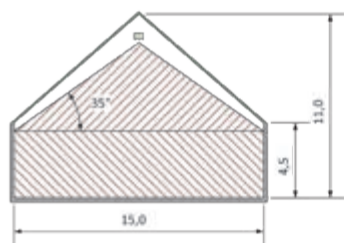

Dimensions in m



Supply to the distributor belt



View of a distributor belt with plough scraper

Manure storehouse with H-shaped distributor

H-shaped distributors are ideal for manure storehouses that are quite wide, but not as high. The main parts of the H-shaped distributing system are three interconnected conveyor belts, all of which can transport the manure into two directions. The conveyor belts

are attached in an H-shape to a cross beam that moves in longitudinal direction through the storehouse. This means there are three lines from which the manure is dropped. With this system, manure must be supplied to the distributor belt in the centre of the storehouse.

It is therefore an ideal solution for first filling just one half of the manure storehouse and the second half later on. The empty half can be used for other purposes in the meantime.

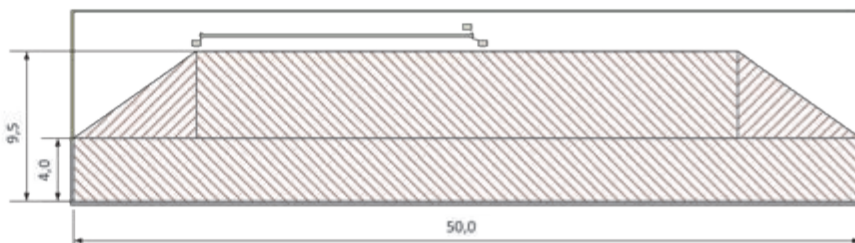
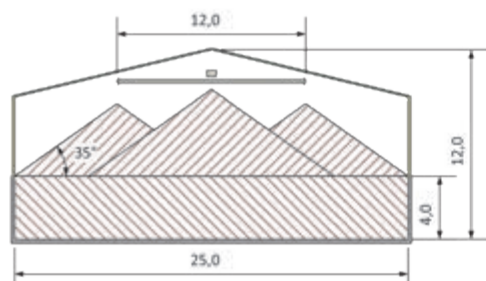

Dimensions in m

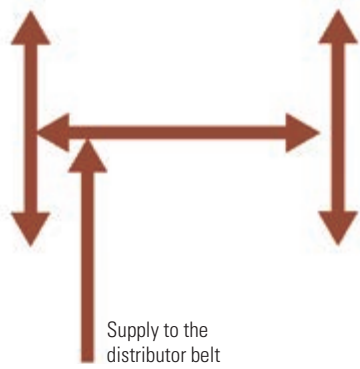

View of an H-shaped distributor

Manure storehouse with distribution system: conveying system that moves longitudinally

The conveying system that moves in longitudinal direction can be used to distribute manure in all types of manure storehouses. The systems consists of three conveyor belts, which can transport the manure in two directions each. The belts are attached to a rail

system. A traction drive moves them longitudinally through the storehouse. Additional conveyor belts with two transport directions are installed between the conveyor belts moving longitudinally. With these additional belts, manure can be supplied

centrally to the different conveyor belts that move longitudinally, based on individual control. The manure is supplied to the distribution system in the middle of the manure storehouse.

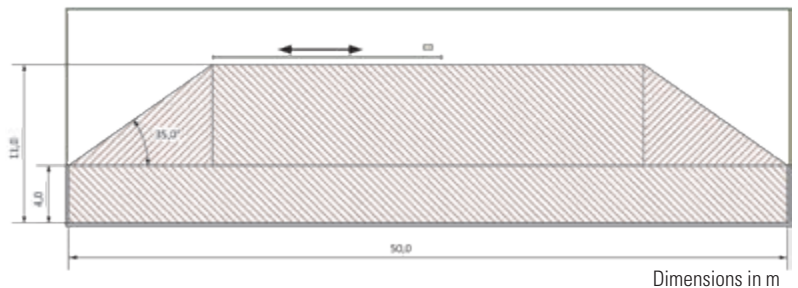
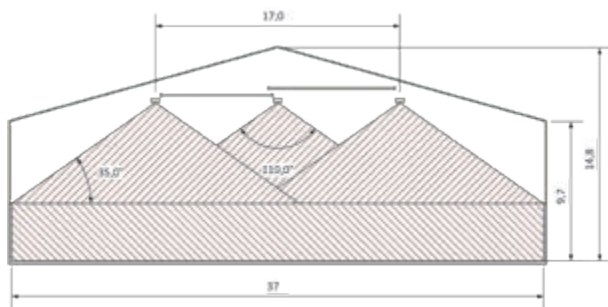

Dimensions in m

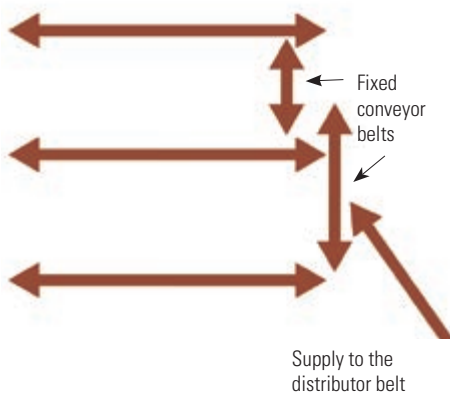

View of a distribution system as conveying system that moves longitudinally with three conveyor belts



View of a distribution system as conveying system that moves longitudinally with two conveyor belts

BD PelletBox 750

Pelletising dried poultry manure at a capacity of approx. 750 kg per hour

Pelletising dry poultry manure and litter from broiler houses is the consequent continuation of clever residue treatment. Why?

- Because pellets are easier to store and to transport.
- Because the volume of the loose material

is reduced by approx. two thirds.

- And because marketing possibilities are much broader.

With BD PelletBox 750, Big Dutchman presents a system that is ideal for farms or farm complexes from 50,000 to 200,000 layers, for example.

The most clever aspect of this system: it is supplied in a container, ready to be connected. This makes it very easy to move the system to different places.



Ready-to-connect delivery of the BD PelletBox 750 in a 40-foot HQ container (12192 mm x 2438 mm x 2896 mm)

Structure and functional principle

The pre-dried manure with a dry matter (DM) content of no less than 85 percent can be stored in the hopper **1** for the short term. From here, a dosing auger **3** transports the manure to the hammer mill **2**, where it is chopped and then transported to the pellet mill.

The compact pellet mill **4** has an output of approx. 750 kg/h, depending on the input material. A trough chain conveyor **7** transports the hot pellets (80 °C to 100 °C) to the pellet cooler **6**, where the pellets are cooled down to approx. 10 °C above inside temperature. The pellets are now stable for storage.

Another dosing auger transports them to the BigBag bagging unit **10**. A pellet screen ensures that fine parts are separated and returned to the hammer mill.

If pellets with a low bacterial count must be produced, a sanitation unit **8** can be installed between the pellet mill and the pellet cooler.

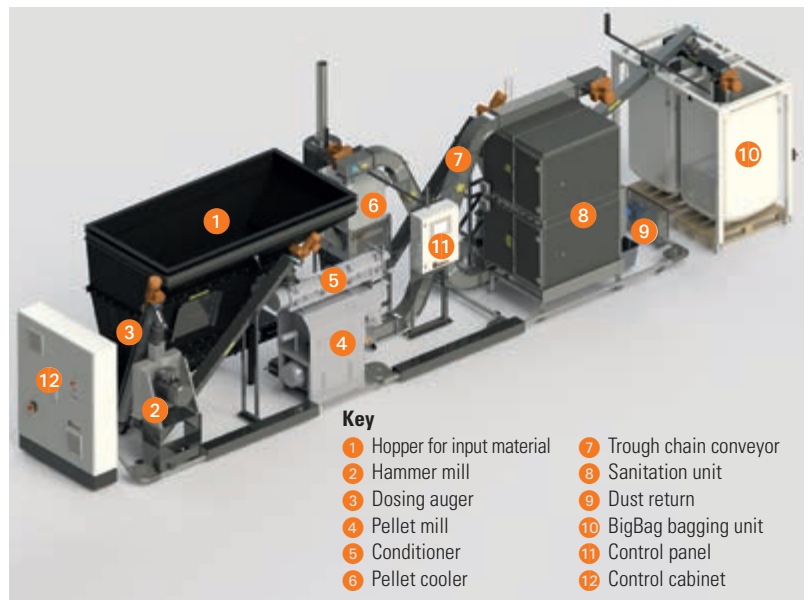

Key

- | | |
|-----------------------------|-------------------------|
| 1 Hopper for input material | 7 Trough chain conveyor |
| 2 Hammer mill | 8 Sanitation unit |
| 3 Dosing auger | 9 Dust return |
| 4 Pellet mill | 10 BigBag bagging unit |
| 5 Conditioner | 11 Control panel |
| 6 Pellet cooler | 12 Control cabinet |

The core of the pelletising system is the robust **pellet mill**, which is characterised by the following features:

- ✓ high pellet quality, very little breaking;
- ✓ stable housing design with integrated motor fixing plates;
- ✓ quiet, energy-efficient and uniform force transmission with a single-stage V-belt drive;
- ✓ magnetic foreign matter separator;

- ✓ symmetrical die geometry for two-way use and thus a longer service life;
- ✓ vertical ring die with two rollers for a high pressure;
- ✓ easy access to the mill via pivoting door;
- ✓ use of high-quality materials, with the conditioner being made of acid-resistant V4A steel.

BD PelletBox and BD PelletTo

- ✓ high pellet quality, virtually no breaking thanks to a pellet diameter of 5 mm and lengths of 20 to 30 mm;
- ✓ use of modern measuring and process technology for a permanently high pellet quality;

BD PelletTower

Pelletising dried poultry manure for large farm complexes

With the BD PelletTower, Big Dutchman has developed a clever and innovative solution for farm complexes that house from 600,000 to

1.5 million layers. The BD PelletTower is very space-saving, with a short distance between the pellet mill and the bagging unit. This

ensures a high quality of the pellets while keeping breaking to a minimum.



BD PelletTower with sanitation unit for 600,000 layers

Structure and functional principle

The pre-dried manure with a dry matter content of no less than 85 percent (bulk density of approx. 330 kg/m³) is stored temporarily in a dosing hopper with scraper floor (storage capacity between 20 and 80 m³). A dosing auger transports the manure into the hammer mill with filter unit, where the material is milled while foreign matter is separated at the same time. A bucket elevator transports the

ground material into an intermediate storage container. From here, another dosing auger dispenses the material into a conditioner. If the dry matter content exceeds 85 percent, water is dispensed into the conditioner (mixing auger with online dry matter measuring). The material is then transported to the pellet mill. In the next step the pellet cooler cools the pellets from 80 or 90°C to 10°C above room

temperature. The pellets can then immediately be filled into BigBags or other available bags. Their bulk density now amounts to up to 700 kg/m³.

A sanitation unit is available as an option. It is placed on an additional level between the pellet mill and the cooler and ensures a final product with a very low bacterial count.

BD PelletTower: advantages and features

- ✓ good visualisation, simple control and monitoring via touchscreen;
- ✓ ideal for transport and storage;
- ✓ simple and accurate spreading of the pellets as fertiliser;
- ✓ versatile marketing possibilities, e.g. in horticulture and viticulture;
- ✓ pelletising of other residues from agriculture (digestate, litter).



OptiSec dimensions

Tiers	4	6	8	10	12	14	16	18
Section height H1 (mm)	1846	2566	3286	4006	4726	5446	6166	6886
Total height H2 (mm)	2664	3384	4101	4824	5544	6264	6984	7704
Number of layers*	80 000	120 000	160 000	200 000	240 000	280 000	320 000	360 000

* Calculation basis: 165 g/day of fresh manure per laying hen at 23 % DM, pre-dried to 45 % DM
One section is 2412 mm long. OptiSec can be delivered with up to 25 sections.

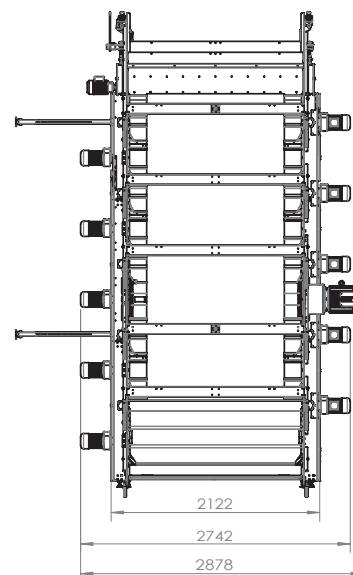
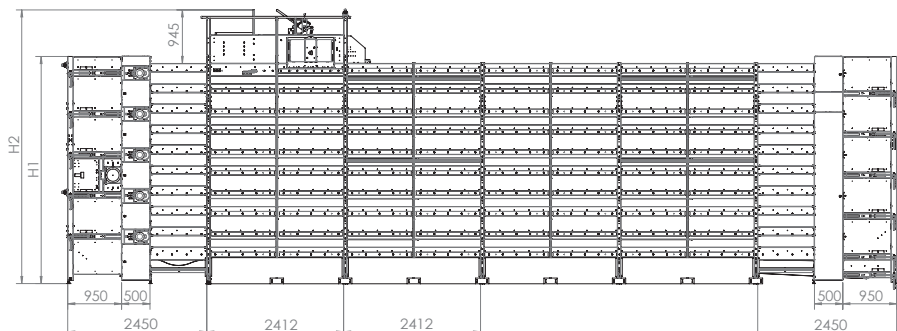

OptiPlate dimensions

Tiers	1	2	3	4	5	6
Section height H1 (mm)	1430	2870	4310	5750	7190	8630
Total height H2 (mm)	2510	3950	5390	6830	8270	9710
Number of layers*	50 000	80 000	120 000	160 000	200 000	240 000

* Calculation basis: 165 g/day of fresh manure per laying hen at 23 % DM, pre-dried to 45 % DM
One section is 2990 mm long. OptiPlate can be delivered with up to 8 sections.

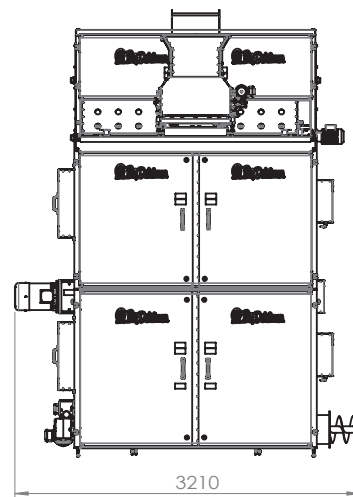
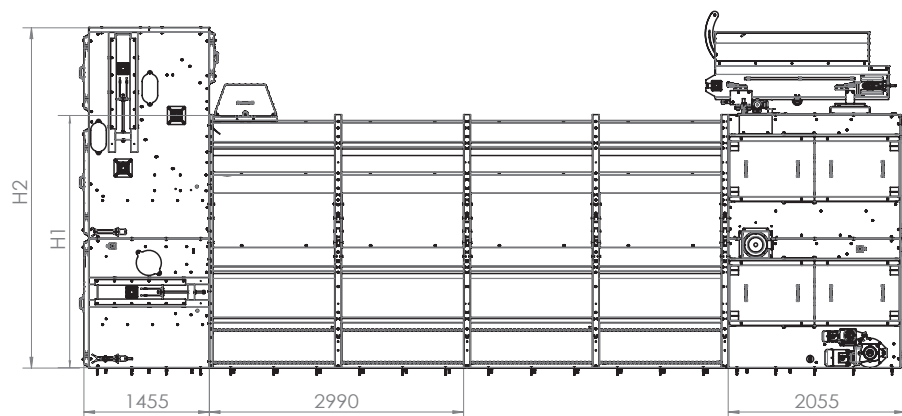

Based on the size of the farm, every manure drying tunnel or steel plate dryer is planned depending on the amount of accumulating manure.

Both systems can also be used to dry digestate from biogas plants or solids separated from liquid manure.



Big Dutchman

Europe, Middle East & Africa:
Big Dutchman International GmbH
P.O. Box 1163 · 49360 Vechta, Germany
Tel. +49(0)4447 801-0 · Fax -237
big@bigdutchman.de · www.bigdutchman.de

USA: Big Dutchman, Inc.
Tel. +1 616 392 5981 · bigd@bigdutchmanusa.com
www.bigdutchmanusa.com

Brazil: Big Dutchman (Brasil) Ltda.
Tel. +55 16 2108 5300 · bdb@bigdutchman.com.br
www.bigdutchman.com.br

Russia: 000 "Big Dutchman"
Tel. +7 495 229 5161 · big@bigdutchman.ru · www.bigdutchman.ru

Asia/Pacific: BD Agriculture (Malaysia) Sdn. Bhd.
Tel. +60 3 334 83 555 · bdasia@bigdutchman.com · www.bigdutchman.com

China: Big Dutchman (Tianjin) Livestock Equipment Co., Ltd.
Tel. +86 10 5632 0188 · bdcnsales@bigdutchman.com
www.bigdutchmanchina.com